

HOVEDPLAN

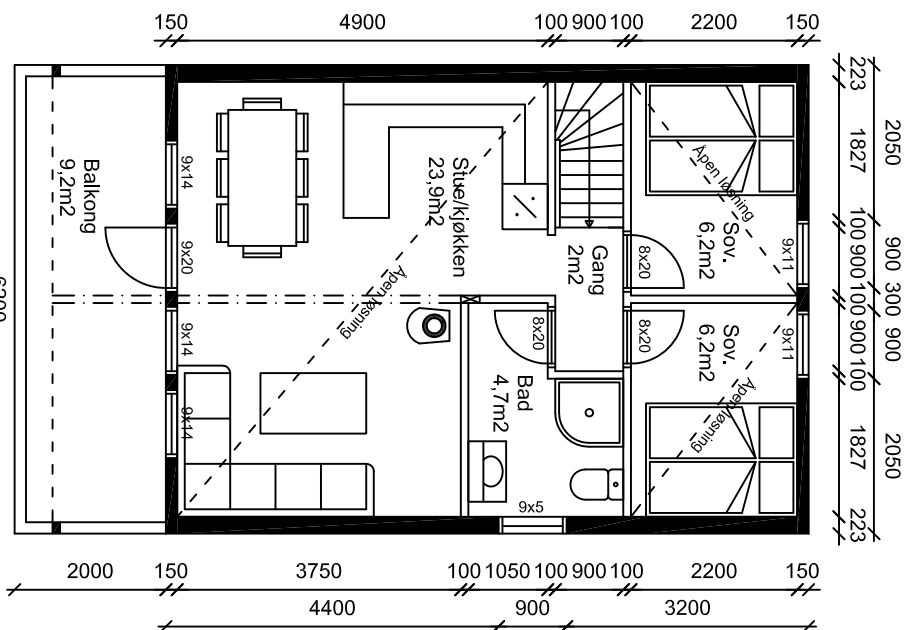

LOFTSPLAN

Grunnflate: 55,4m²  
BYA: 68,8m²  
BRA: 99,1m²

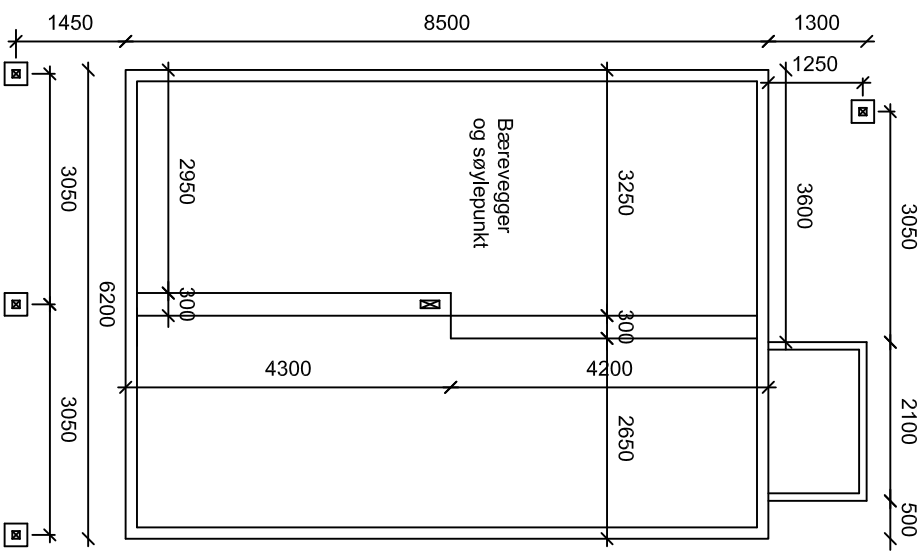

Betongplan

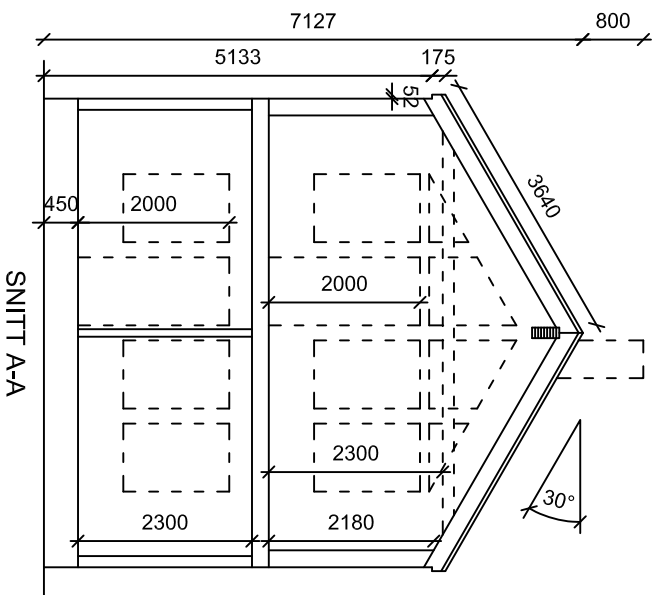

SNITT A-A

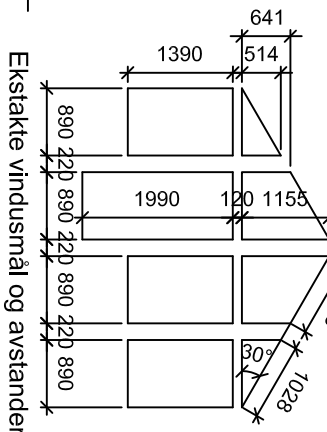

Ekstakte vindusmal og avstander

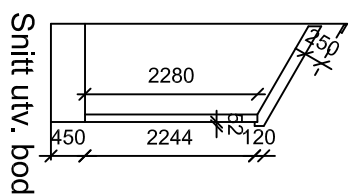

Snitt utv. bod

Mål fra topp sper  
til underkant vannbrett

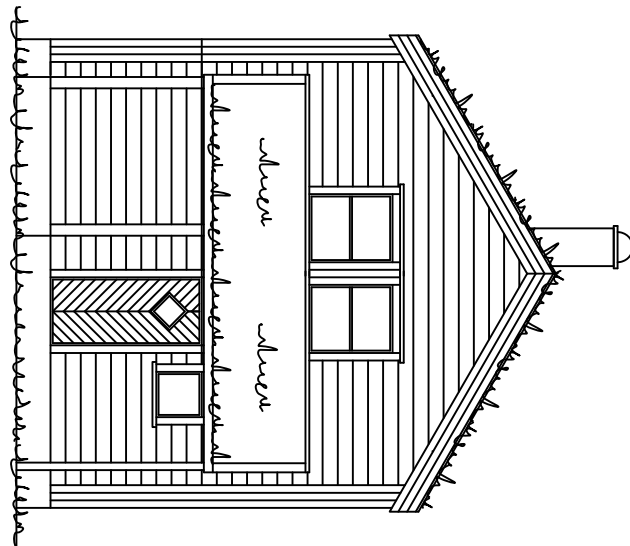

FASADE MOT

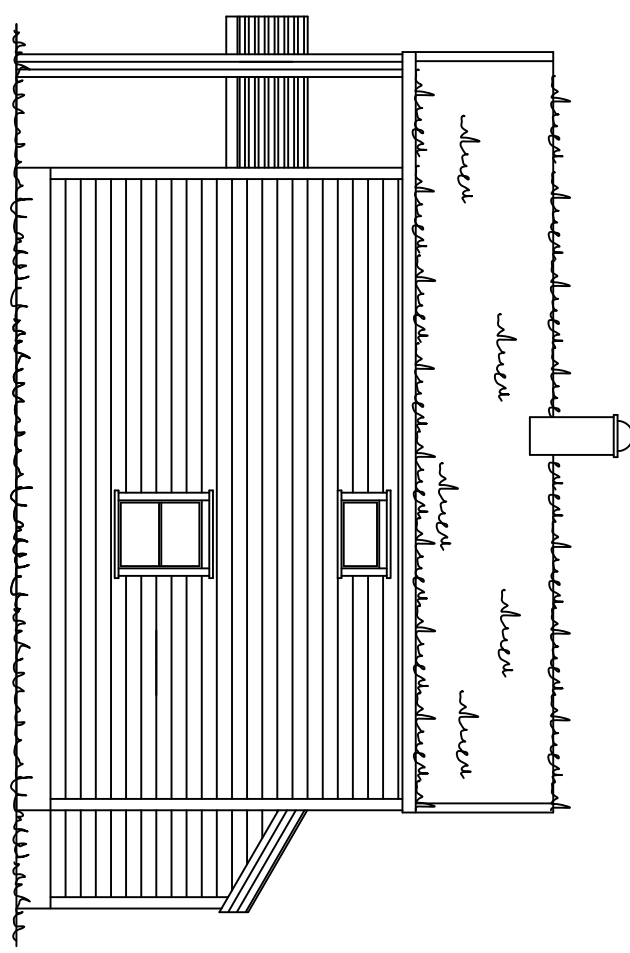

FASADE MOT

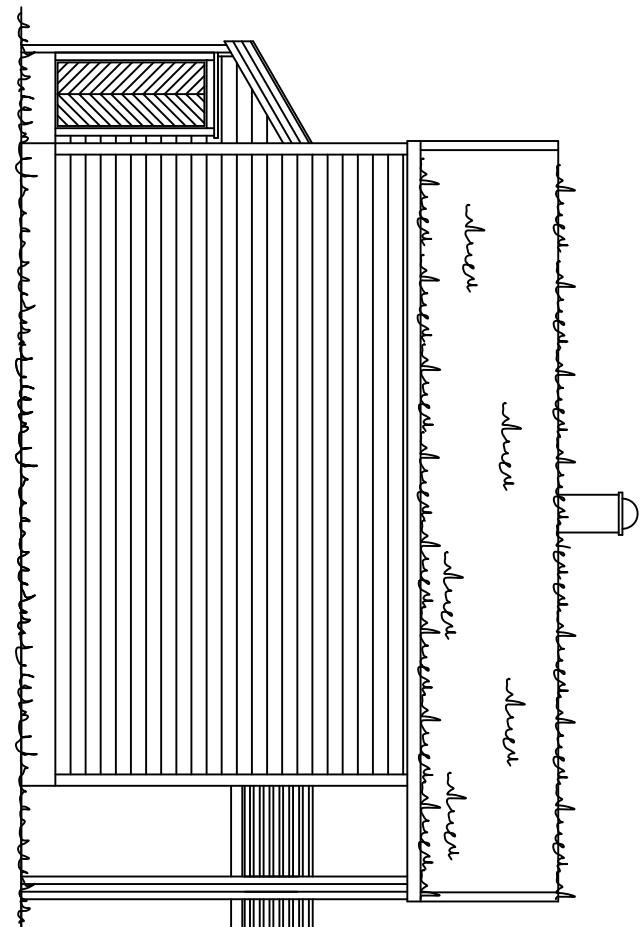

FASADE MOT

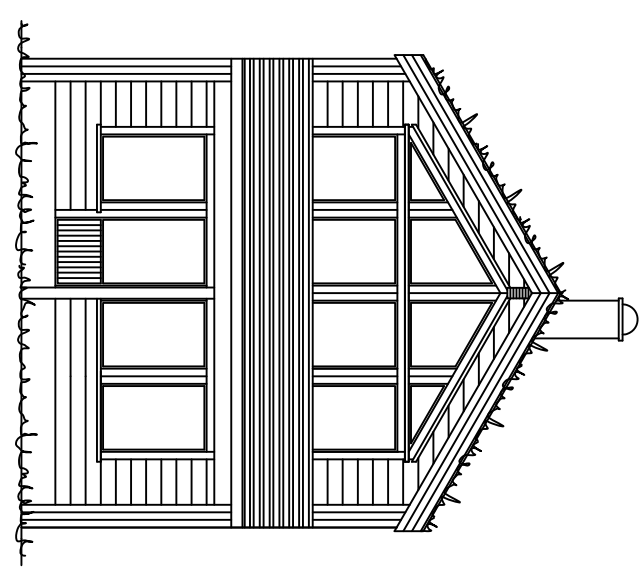

FASADE MOT



4540 ASERAL  
Tlf : 38283800 Fax : 38283801  
Tlf : Raymond 90752181  
Tlf : Eivind 91564829  
Mail : raymond@aseralhytter.no  
Mail : eivind@aseralhytter.no

Byggherre :	<b>Fritidsbygg AS</b>
Prosjekt :	N5 område tomter 6-10
Byggeplass :	Bortelid
Type tegning :	Fasade, plan og snitt
Tegningsnr. :	
Tegnet av :	R. S
Andre opplysninger :	
Kommune :	Aseral
Gnr. Bnr. :	
Målestokk :	1:100
Dato :	13.05.2022